

S U M M I T[®]
T A P E R E D H I P S Y S T E M

SUMMIT[®] TAPERED HIP SYSTEM

Surgical Technique



PRE-OPERATIVE PLANNING

Determination of Leg Length Discrepancy

Perform clinical and radiograph analysis to determine leg length management (Figure 1).



Figure 1: Leg Length Management

Acetabular Cup Sizing and Positioning

Use A/P radiograph to determine acetabular component position.

Use the PINNACLE® Acetabular Cup System template overlays to determine the correct implant size (Figure 2).

Optimizing the position and bone contact are the main objectives in cementless acetabular fixation.

Mark the center of rotation of bearing surface on A/P radiograph.

The vertical distance between the planned center of rotation of the acetabular component and the center of rotation of femoral head constitutes the distance the leg length will be adjusted.

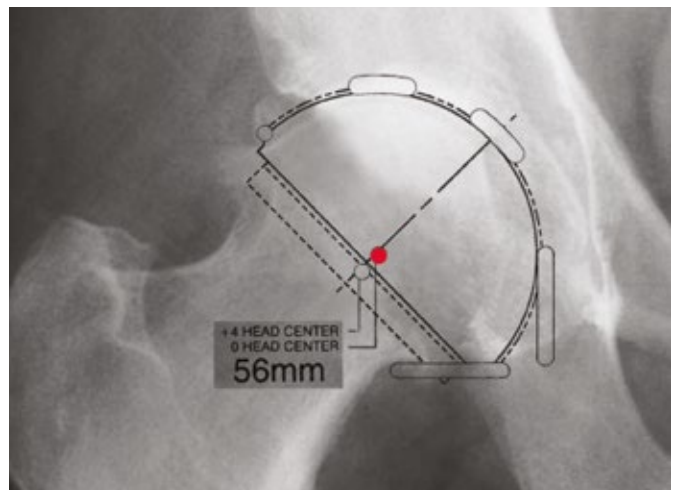

Figure 2: Cup Sizing and Positioning

Note: The targeted shell abduction (as measured on radiographs) should be 40–45 degrees taking into account each individual patient's local soft tissue and anatomic landmarks.

The targeted shell anteversion (as measured on radiographs) should be 15–20 degrees taking into account each individual patient's local soft tissue and anatomic landmarks.

Femoral Stem Selection

Select the template that fits the proximal femur and equalizes the leg lengths.

The femoral template should be in-line with the long axis of femur.

Mark the neck resection line at the point where the selected stem provides the desired amount of leg length.

Verify the chosen stem size also fits into the lateral plane and check for three point fixation (Figure 3).

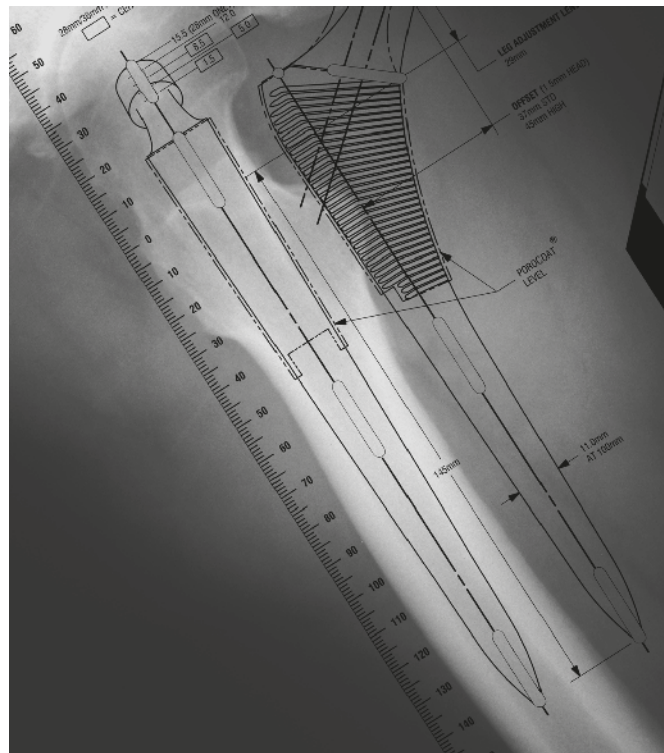

Figure 3: Three Point Fixation

FEMORAL NECK OSTEOTOMY

Align the neck resection guide with the long axis of the femur (Figure 4).

The neck resection guide should be used to determine the level of the femoral neck resection in conjunction with pre-operative templating.

Mark the resection line using electrocautery or methylene blue.*

Resect the femoral head.

***Tip:** Make a conservative neck resection initially and use the calcar planer to adjust.



Figure 4: Neck Osteotomy

FEMORAL CANAL INITIATION

Option 1

Medullary Canal Access

Place the IM initiator at the posterior margin of the neck resection laterally near the piriformis fossa.

Advance the IM initiator until sufficient circumferential clearance for the box osteotome and canal probe is achieved (Figure 5).



Figure 5: Medullary Canal Access

Option 2

Box Osteotome

Use the box osteotome to enter the femoral canal at the junction of the femoral neck and greater trochanter (Figure 6).

If needed the box osteotome may be used to clear bone laterally.



Figure 6: Box Osteotome

FEMORAL PREPARATION

Canal Probing

Utilize the tapered canal probe to establish a direct pathway to the medullary canal. Advance the probe so that the superior margin of the cutting flutes meet the neck resection (Figure 7).

Note: The probe should pass easily if proper alignment has been achieved.

Tip: Circumferential clearance of the probe is important to avoid reaming in the varus orientation.

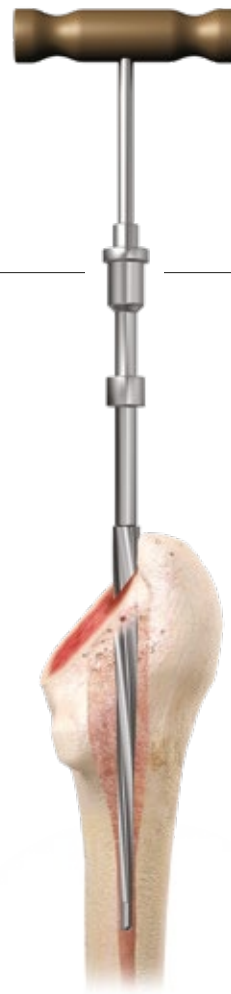

Figure 7: Canal Probing

Alignment Verification and Lateralizing

The path established by the canal probe will dictate the route for trochanteric reaming, tapered reamers and broaches.

Note: It is important to gain neutral alignment of the canal.

Trochanteric reaming (lateralizing) may be used to lateralize the proximal entry point for the tapered reamers; broaches aid in neutral stem alignment (Figure 8).

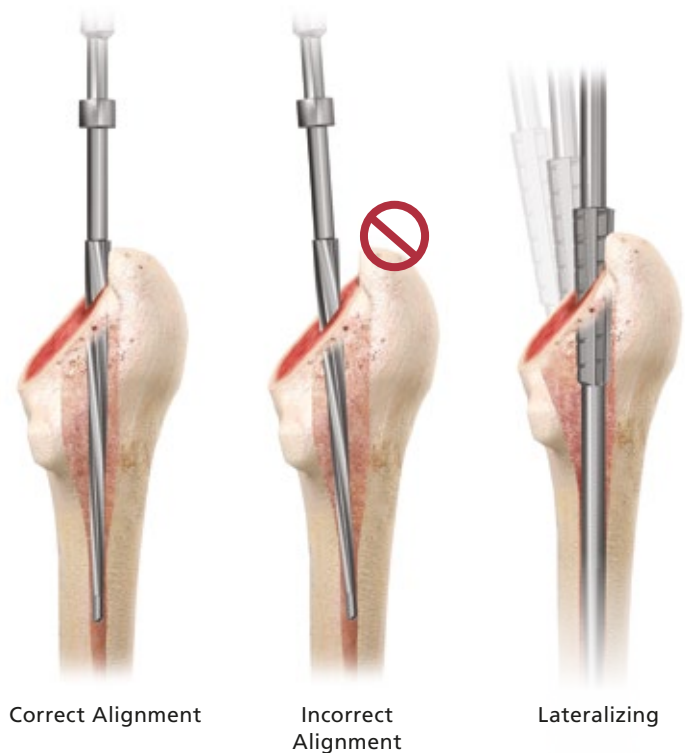

Figure 8

TAPERED REAMING

Tapered Reaming

Sequential Ream starting 2–3 sizes below the pre-operatively templated size.

Example: If the hip pre-operatively templated for a size 6 implant then tapered reaming would begin with the size 2–3 reamer and progress to the size 6–7 reamer.

Each reamer has dual depth calibration lines for each of the two stem sizes, distally located for calcar referencing and proximally for greater trochanter referencing (Figure 9).

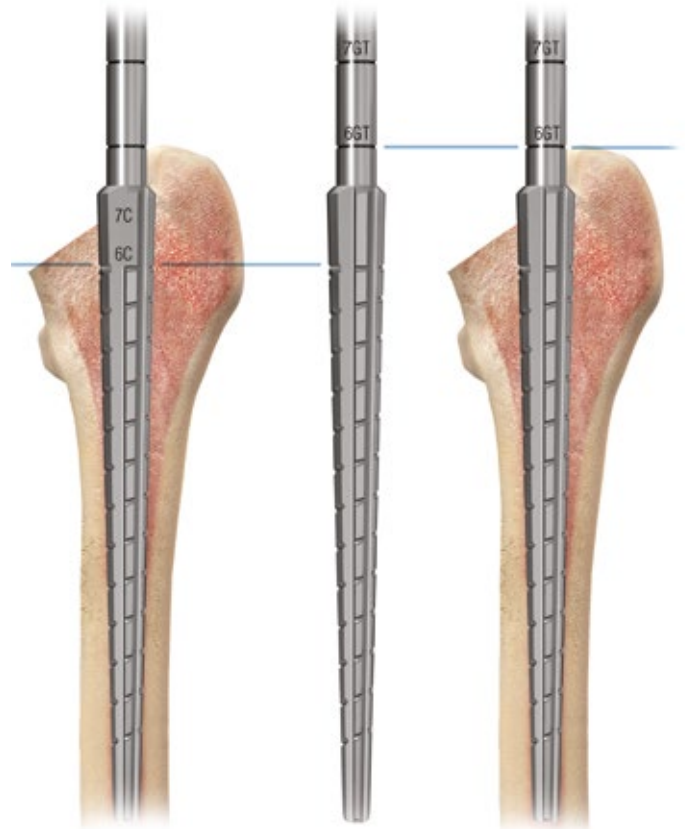

Figure 9: Tapered Reaming

FEMORAL BROACHING

Broaching the Femur

With the broach oriented laterally towards the greater trochanter, broach sequentially starting 2–3 sizes below the pre-operatively templated size.

There is one broach for every implant size.

During sequential broaching, the broach may become difficult to remove, therefore the broach extractor is recommended.

The final broach should fit and fill the proximal femur with the top of the cutting teeth at the desired neck resection. This final broach should feel rotationally stable.

Example: If the femur was reamed to a size 6, it should then be broached to a size 6 and assessed for axial and rotational stability.

Tip: The SUMMIT Instrumentation is designed to prepare the femur line-to-line. The porous-coated region of the femoral component is oversized by 0.375mm per side relative to the instrumentation. If the broach size is countersunk more than 4mm below the neck resection, re-evaluate the resection level. If the neck resection level is determined to be correct, the next larger size broach is recommended.



Figure 10: Femoral Broaching

TRIAL REDUCTION

Calcar Planing/Milling

Calcar planing is optional.

Create a definitive landmark for stem insertion by milling a precise resection level.

Place the planer over the broach stud and mill the calcar to the broach face (Figure 11).

Note: Make sure the planer is rotating prior to engaging the calcar.



Figure 11: Calcar Planing / Milling

Trial Reduction

Standard and high offset neck segments and trial modular heads are available to assess proper component position, joint stability and range of motion (Figure 12).

Trial heads are color coded to indicate different neck offsets. The brown +5 head is the neutral head and doesn't change the offset of the trial.



Figure 12: Trial Reduction

Broach Extraction

Use the broach handle or broach extractor to remove the final broach.

FINAL IMPLANTATION

Final Implantation

Select the stem size that corresponds to the final broach. Introduce the implant into the femoral canal by hand and orient the implant with proper alignment and version. Using moderate mallet blows, advance the stem into position. In the area of POROCOAT® Porous Coating, the implant is oversized by 0.375mm per side relative to the broach.

Excessive force should not be needed to seat the stem. The implant is fully seated when the top of the POROCOAT Coating reaches the level where the face of the broach previously sat and the implant is stable (Figure 14). It is possible for the implant to be seated and stable and still display 2–3 rows of POROCOAT Coating proximally (Figure 13).



Figure 13: Final Implantation

Femoral Head Impaction

Following the final trial reduction, clean and dry the taper to ensure it is free of debris. Place the appropriate femoral head onto the taper. Using the head impactor, engage the head with light taps. Clean the bearing surfaces and reduce the hip. (Figure 14).

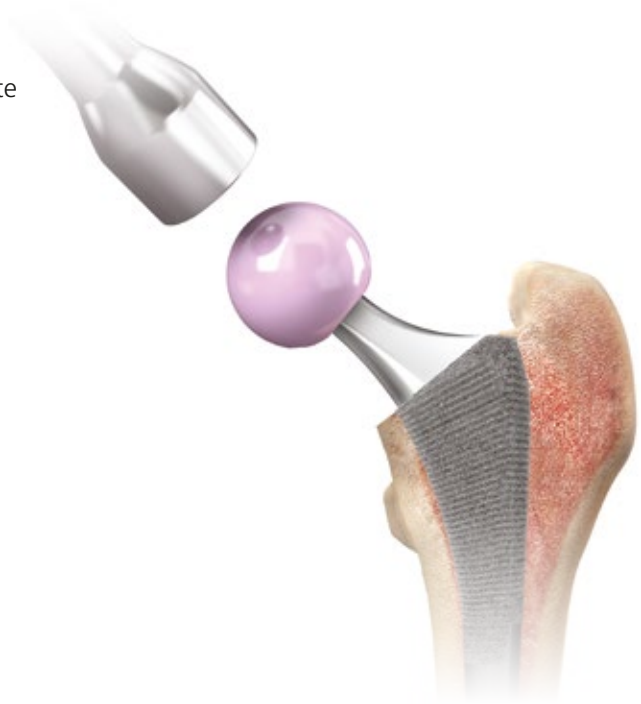

Figure 14: Femoral Head Impaction

SURGICAL TIPS

Tapered Reaming

Resistance and chatter from cortical engagement may be used as a signal to cease tapered reaming. The reamer depth reference lines for either referencing landmark are calibrated to the center of rotation of the corresponding femoral component with a 28mm + 5 ARTICUL/EZE® Femoral Head.

It is important to ensure the reaming is performed sequentially through the reamer sizes. The reamer sizes are designed to ensure the reamed cavity does not breach the cortical bone.

Femoral Broaching

Ensure sequential reaming is completed before broaching.

If the broach size is countersunk more than 4mm below the neck resection, re-evaluate the resection level. If the neck resection level is determined to be correct, ream up and use the next size broach.

Trial Reduction

Three sources of instability:

- 1. Soft tissue laxity:** This can be resolved by increasing modular head length or by choosing the high offset option. In extreme cases, these solutions can be employed in conjunction with trochanteric advancement.
- 2. Component orientation:** Choosing a face-changing acetabular liner and positioning it in the proper orientation to achieve the desired stability can correct this condition. If the face-changing liner does not provide adequate stability, the acetabular shell may require repositioning.
- 3. Bony impingement:** Where instability is due to acetabular osteophytes or trochanteric prominence, relieve these areas. Substitution of a longer modular head or selecting the high offset neck trial may be required to relieve bony impingement.

Inserter Selection

When using the retaining inserter, verify that it is assembled with the inserter shaft threaded into the inserter handle. Ensure the tines in the inserter are aligned with the recesses of the inserter platform on the top of the implant. Fully engage the threads of the inserter into the implant to ensure the inserter is securely attached to the implant.

TECHNICAL SPECIFICATIONS

	Stem Length (A)	Neck Length (B)										
		-2.0	1.0	1.5	4.0	5.0	7.0	8.5	9.0	12.0	13.0	15.5
1 Std	125mm	23.7	26.7	27.2	29.7	30.7	32.7	34.2	34.7	37.7	38.7	41.2
1 High	125mm	27.6	30.6	31.1	33.6	34.6	36.6	38.1	38.6	41.6	42.6	45.1
2 Std	130mm	25.2	28.2	28.7	31.2	32.2	34.2	35.7	36.2	39.2	40.2	42.7
2 High	130mm	29.1	32.1	32.6	35.1	36.1	38.1	39.6	40.1	43.1	44.1	46.6
3 Std	135mm	25.2	28.2	28.7	31.2	32.2	34.2	35.7	36.2	39.2	40.2	42.7
3 High	135mm	29.1	32.1	32.6	35.1	36.1	38.1	39.6	40.1	43.1	44.1	46.6
4 Std	140mm	27.1	30.1	30.6	33.1	34.1	36.1	37.6	38.1	41.1	42.1	44.6
4 High	140mm	32.3	35.3	35.8	38.3	39.3	41.3	42.8	43.3	46.3	47.3	49.8
5 Std	145mm	27.1	30.1	30.6	33.1	34.1	36.1	37.6	38.1	41.1	42.1	44.6
5 High	145mm	32.3	35.3	35.8	38.3	39.3	41.3	42.8	43.3	46.3	47.3	49.8
6 Std	150mm	28.9	31.9	32.4	34.9	35.9	37.9	39.4	39.9	42.9	43.9	46.4
6 High	150mm	34.2	37.2	37.7	40.2	41.2	43.2	44.7	45.2	48.2	49.2	51.7
7 Std	155mm	28.9	31.9	32.4	34.9	35.9	37.9	39.4	39.9	42.9	43.9	46.4
7 High	155mm	34.2	37.2	37.7	40.2	41.2	43.2	44.7	45.2	48.2	49.2	51.7
8 Std	160mm	30.8	33.8	34.3	36.8	37.8	39.8	41.3	41.8	44.8	45.8	48.3
8 High	160mm	36.0	39.0	39.5	42.0	43.0	45.0	46.5	47.0	50.0	51.0	53.5
9 Std	165mm	30.8	33.8	34.3	36.8	37.8	39.8	41.3	41.8	44.8	45.8	48.3
9 High	165mm	36.0	39.0	39.5	42.0	43.0	45.0	46.5	47.0	50.0	51.0	53.5
10 Std	170mm	32.7	35.7	36.2	38.7	39.7	41.7	43.2	43.7	46.7	47.7	50.2
10 High	170mm	37.9	40.9	41.4	43.9	44.9	46.9	48.4	48.9	51.9	52.9	55.4

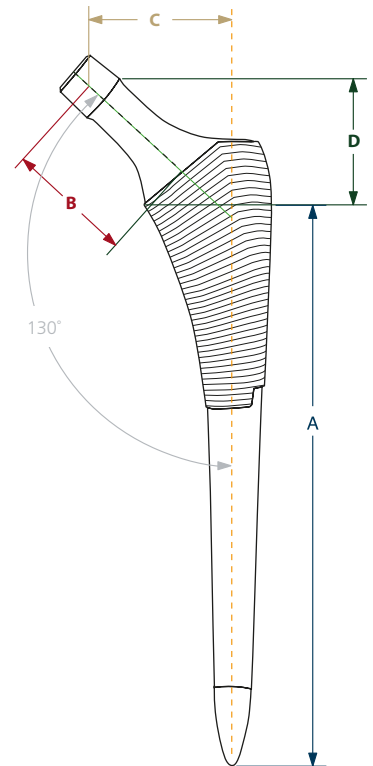

	Offset (C)											Leg Length Adjustment (D)										
	-2.0	1.0	1.5	4.0	5.0	7.0	8.5	9.0	12.0	13.0	15.5	-2.0	1.0	1.5	4.0	5.0	7.0	8.5	9.0	12.0	13.0	15.5
1 Std	30.3	32.6	33.0	34.9	35.7	37.2	38.4	38.8	41.1	41.8	43.7	22.9	24.8	25.2	26.6	27.4	28.7	29.6	30.0	31.9	32.5	34.2
1 High	36.3	38.6	39.0	40.9	41.7	43.2	44.4	44.8	47.1	47.8	49.7	22.9	24.8	25.2	26.6	27.4	28.7	29.6	30.0	31.9	32.5	34.2
2 Std	32.3	34.6	35.0	36.9	37.7	39.2	40.4	40.8	43.1	43.8	45.7	23.7	25.6	26.0	27.4	28.2	29.5	30.4	30.8	32.7	33.3	35.0
2 High	38.3	40.6	41.0	42.9	43.7	45.2	46.4	46.8	49.1	49.8	51.7	23.7	25.6	26.0	27.4	28.2	29.5	30.4	30.8	32.7	33.3	35.0
3 Std	32.3	34.6	35.0	36.9	37.7	39.2	40.4	40.8	43.1	43.8	45.7	24.4	26.3	26.7	28.1	28.9	30.2	31.1	31.5	33.4	34.0	35.7
3 High	38.3	40.6	41.0	42.9	43.7	45.2	46.4	46.8	49.1	49.8	51.7	24.4	26.3	26.7	28.1	28.9	30.2	31.1	31.5	33.4	34.0	35.7
4 Std	34.3	36.6	37.0	38.9	39.7	41.2	42.4	42.8	45.1	45.8	47.7	25.7	27.6	28.0	29.4	30.2	31.5	32.4	32.8	34.7	35.3	37.0
4 High	42.3	44.6	45.0	46.9	47.7	49.2	50.4	50.8	53.1	53.8	55.7	25.7	27.6	28.0	29.4	30.2	31.5	32.4	32.8	34.7	35.3	37.0
5 Std	34.3	36.6	37.0	38.9	39.7	41.2	42.4	42.8	45.1	45.8	47.7	26.4	28.3	28.7	30.1	30.9	32.2	33.1	33.5	35.4	36.0	37.7
5 High	42.3	44.6	45.0	46.9	47.7	49.2	50.4	50.8	53.1	53.8	55.7	26.4	28.3	28.7	30.1	30.9	32.2	33.1	33.5	35.4	36.0	37.7
6 Std	36.3	38.6	39.0	40.9	41.7	43.2	44.4	44.8	47.1	47.8	49.7	27.7	29.6	30.0	31.4	32.2	33.5	34.4	34.8	36.7	37.3	39.0
6 High	44.3	46.6	47.0	48.9	49.7	51.2	52.4	52.8	55.1	55.8	57.7	27.7	29.6	30.0	31.4	32.2	33.5	34.4	34.8	36.7	37.3	39.0
7 Std	36.3	38.6	39.0	40.9	41.7	43.2	44.4	44.8	47.1	47.8	49.7	28.4	30.3	30.7	32.1	32.9	34.2	35.1	35.5	37.4	38.0	39.7
7 High	43.6	45.9	46.3	48.2	49.0	50.5	51.7	52.1	54.4	55.1	57.0	28.4	30.3	30.7	32.1	32.9	34.2	35.1	35.5	37.4	38.0	39.7
8 Std	38.3	40.6	41.0	42.9	43.7	45.2	46.4	46.8	49.1	49.8	51.7	29.7	31.6	32.0	33.4	34.2	35.5	36.4	36.8	38.7	39.3	41.0
8 High	45.6	47.9	48.3	50.2	51.0	52.5	53.7	54.1	56.4	57.1	59.0	29.7	31.6	32.0	33.4	34.2	35.5	36.4	36.8	38.7	39.3	41.0
9 Std	38.3	40.6	41.0	42.9	43.7	45.2	46.4	46.8	49.1	49.8	51.7	30.4	32.3	32.7	34.1	34.9	36.2	37.1	37.5	39.4	40.0	41.7
9 High	46.3	48.6	49.0	50.9	51.7	53.2	54.4	54.8	57.1	57.8	59.7	30.4	32.3	32.7	34.1	34.9	36.2	37.1	37.5	39.4	40.0	41.7
10 Std	40.3	42.6	43.0	44.9	45.7	47.2	48.4	48.8	51.1	51.8	53.7	31.7	33.6	34.0	35.4	36.2	37.5	38.4	38.8	40.7	41.3	43.0
10 High	48.3	50.6	51.0	52.9	53.7	55.2	56.4	56.8	59.1	59.8	61.7	31.7	33.6	34.0	35.4	36.2	37.5	38.4	38.8	40.7	41.3	43.0

ORDERING CODES

IMPLANTS

SUMMIT POROCOAT Stem Standard Offset

Stem Standard Offset	Size
1570-01-070	1
1570-01-080	2
1570-01-090	3
1570-01-100	4
1570-01-110	5
1570-01-120	6
1570-01-135	7
1570-01-150	8
1570-01-165	9
1570-01-180	10

SUMMIT POROCOAT Stem High Offset

Stem High Offset	Size
1570-11-070	1
1570-11-080	2
1570-11-090	3
1570-11-100	4
1570-11-110	5
1570-11-120	6
1570-11-135	7
1570-11-150	8
1570-11-165	9
1570-11-180	10

SUMMIT DUOFIX™ Stem Standard Offset

Stem Standard Offset	Size
1570-02-070	1
1570-02-080	2
1570-02-090	3
1570-02-100	4
1570-02-110	5
1570-02-120	6
1570-02-135	7
1570-02-150	8
1570-02-165	9
1570-02-180	10

SUMMIT DUOFIX Stem High Offset

Stem High Offset	Size
1570-12-070	1
1570-12-080	2
1570-12-090	3
1570-12-100	4
1570-12-110	5
1570-12-120	6
1570-12-135	7
1570-12-150	8
1570-12-165	9
1570-12-180	10

SUMMIT Cemented Stem Standard Offset

Stem Standard Offset	Size
1570-03-080	2
1570-03-090	3
1570-03-100	4
1570-03-110	5
1570-03-120	6
1570-03-135	7
1570-03-150	8

SUMMIT Cemented Stem High Offset

Stem High Offset	Size
1570-13-090	3
1570-13-100	4
1570-13-110	5
1570-13-120	6
1570-13-135	7
1570-13-150	8

Note: All SUMMIT Tapered Hip System femoral implants are compatible with the DePuy Synthes Joint Reconstruction* ARTICUL/EZE 12/14 Taper.

INSTRUMENTATION

General Instrumentation

2570-00-000	Universal Broach Handle
2570-00-002	Broach Extractor
2570-04-100	Calcar Planer-Small
2570-04-200	Calcar Planer-Large
2598-07-570	Retaining Implant Inserter
2570-05-100	Standard Implant Inserter
2570-10-000	Case Complete
2570-01-600	Universal Neck Resection Guide
2001-42-000	T-handle
2001-80-501	IM Initiator
2001-65-000	Femoral Head Impactor
2354-10-000	Muller AWL Reamer
2611-20-000	Core 2 Instrument Case Complete
85-3927	Femoral Rasp
85-4673	Box Osteotome
2002-25-000	Anteversión Osteotome
85-3928	Broach Handle Alignment Rod
2570-00-005	Lateralizer

Tapered Reamer Size

2570-02-000	0/1
2570-02-100	2/3
2570-02-200	4/5
2570-02-300	6/7
2570-02-400	8/9
2570-02-500	10

Broach Size

2570-00-060	0
2570-00-070	1
2570-00-080	2
2570-00-090	3
2570-00-100	4
2570-00-110	5
2570-00-120	6
2570-00-135	7
2570-00-150	8
2570-00-165	9
2570-00-180	10

Standard Neck Segment Size

2570-03-000	0/1
2570-03-100	2/3
2570-03-200	4/5
2570-03-300	6/7
2570-03-400	8/9
2570-03-500	10

High Neck Segment Size

2570-03-050	0/1
2570-03-150	2/3
2570-03-250	4/5
2570-03-350	6/7
2570-03-450	8/9
2570-03-550	10

This publication is not intended for distribution in the USA.

The third-party trademarks used herein are trademarks of their respective owners.



Johnson & Johnson Medical Limited. Baird House, 4 Lower Gilmore Bank, Edinburgh, EH3 9QP, United Kingdom.
Incorporated and registered in Scotland under company number SC132162.

DePuy Orthopaedics, Inc.
700 Orthopaedic Drive
Warsaw, IN 46582
USA
Tel: +1 (800) 366 8143
Fax: +1 (800) 669 2530

DePuy International Ltd
St Anthony's Road
Leeds LS11 8DT
England
Tel: +44 (0)113 270 0461

DePuy (Ireland)
Loughbeg
Ringaskiddy
Co. Cork
Ireland
Tel: +353 21 4914 000
Fax: +353 21 4914 199



depuysynthes.com